

Convenience at a Touch

M300 Multi-parameter Transmitter



High Flexibility

- Multi-parameter transmitter for pH/ORP, conductivity, DO and ozone
- Mixed-mode input for use with analog or innovative digital ISM sensors
- Process or Water version; 1-/2-channel version; ¼ DIN or ½ DIN version

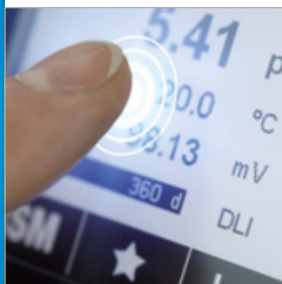

Intuitive Operation

- Brilliant 4" TFT touchscreen allowing quick access to menus
- Intuitive GUI with clear display of important measurement information
- User-friendly menu structure with 10 languages selectable



Fast Startup

- Fast commissioning and error-free start-up thanks to Plug and Measure functionality
- Direct connection of pre-calibrated sensors with iSense
- Safe and user-friendly sensor wiring
- Configuration via the Transmitter Configuration Tool (TCT) or USB stick saves time

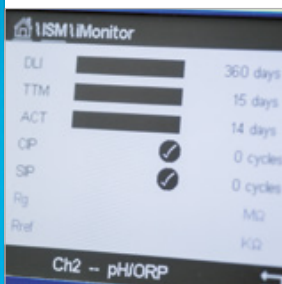

Predictive Maintenance

- Advanced ISM functionality provides predictive maintenance, e.g. DLI, ACT and TTM, to prevent unplanned shut-down and reduce maintenance
- iMonitor for all ISM diagnostics info at a glance



ISM®

CE

UL US LISTED

Versatile and User-Friendly

for a Wide Range of Applications and Industries

The multi-parameter M300 Water and M300 Process transmitter series' for pH/ORP, dissolved oxygen, conductivity/resistivity and ozone measurements offer exceptional measurement performance as well as excellent user ergonomics.

The high contrast black and white touchscreen together with the harmonized menu structure for all parameters, facilitates navigation and ensures easy and user-friendly operation. Online diagnostics information allows you to schedule sensor maintenance or replacement. The clearly visible diagnostic information lets you know when it is time to do maintenance or calibration of sensors equipped with Intelligent Sensor Management (ISM®) technology. Transmitter configuration using the Transmitter Configuration Tool (TCT) can be uploaded to the M300 via PC or a USB stick. A configuration can be downloaded from the M300 to USB stick for use on another unit. The USB interface can also be used for data logging

Technical data of the M300 4-wire transmitter series

Power supply	100 to 240VAC 50/60 Hz 10VA 20 to 30VDC 10VA
Analog outputs	4 for 2-channel versions (2 for 1-channel versions) 0/4 to 20mA, 22mA alarm, galvanically isolated
Relays	2 SPST, mechanical, 250VAC or 30VDC, 3A 2 SPST, Reed, 250VAC or 250VDC, 0.5A, 10W
Digital inputs	2 for 2-channel versions (1 for 1-channel versions)
PID controller	Yes
User interface	4.0" TFT b/w touchscreen, 320×240 pixels
Languages	10 (English, German, French, Italian, Spanish, Portuguese, Russian, Japanese, Korean and Chinese)
USB interface	1 USB host: data logging, loading or saving configuration 1 USB device: software update interface
Ambient temperature	-10 to +50 °C (+14 to +122 °F)
Relative humidity	0 to 90 % non-condensing
Enclosure rating	½ DIN: IP 65; ¼ DIN: IP 65 (front)
Approvals and certificates	cULus, CE

M300 parameter fit guide

	M300 Process		M300 Water		M300 Water Cond/Res	
	Analog	ISM	Analog	ISM	Analog	ISM
pH/ORP	•	•	•	•	–	–
pH/pNa	–	•	–	–	–	–
UniCond 2-e	–	•	–	•	–	–
UniCond 4-e	–	•	–	•	–	–
Conductivity 2-e/4-e	•	–/•	•	–/•	•	–
Amp. O ₂ ppm/ppb	•/• ¹⁾	•	–/• ¹⁾	–/•	–	–
Dissolved ozone	•	•	•	•	–	–

1) Thornton high performance dissolved oxygen sensor only.

Ordering information

Transmitter	Order No.
M300 Process 1-channel ¼ DIN	30 280 770
M300 Process 1-channel ½ DIN	30 280 771
M300 Process 2-channel ¼ DIN	30 280 772
M300 Process 2-channel ½ DIN	30 280 773
M300 Water Cond/Res 2-channel ¼ DIN	30 280 774
M300 Water Cond/Res 2-channel ½ DIN	30 280 775
M300 Water 1-channel ¼ DIN	30 280 776
M300 Water 1-channel ½ DIN	30 280 777
M300 Water 2-channel ¼ DIN	30 280 778
M300 Water 2-channel ½ DIN	30 280 779

► www.mt.com/m300

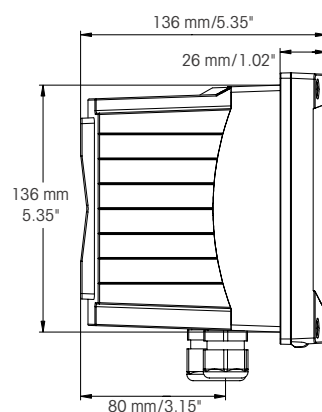
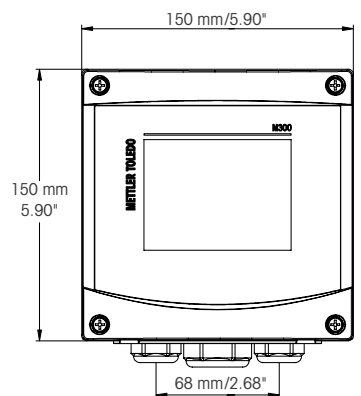

Dimension Drawing M300 ½ DIN

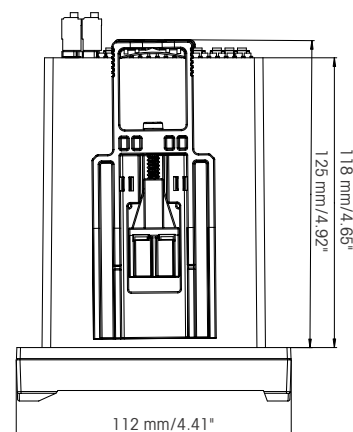

Dimension Drawing M300 ¼ DIN

METTLER TOLEDO Group

Process Analytics
Local contact: www.mt.com/pro-MOs

ISM, iSense and iMonitor are trademarks of the METTLER TOLEDO Group.

Subject to technical changes.
01/2019 © METTLER TOLEDO. All rights reserved.
Printed in Switzerland. PA2068en C.

www.mt.com/pro

For more information

