



The inline compact sensor **SONOFLOW IL.52 V2.0** serves to detect smallest flow rates of liquids quickly.

Constructed as a built-in component for machines and apparatuses, the sensor could be easily mechanically installed and electrically integrated into the control system. Due to the current, frequency and switching outputs industrial dosing applications can be supported. The RS485 interface allows bus operation of up to 12 sensors in rough industrial environments.

Specifically designed for the use in areas with rigorous hygiene requirements, the sensor is suitable for circulation cleaning and steam sterilization.

General Data

SONOFLOW IL.52/3 V2.0		
Ultrasonic Flow Sensor for Liquids		
Order-No.	IL.52/3 PEEK/Viton	200 08 0001
	IL.52/3 PEEK/FFKM	200 08 0044
Dimensions (L x W x H)	148 x 59 x 46 mm	
Weight	370 g	
Media	Water or other acoustically transparent, low-viscosity liquids (For applications with high-viscosity liquids, e.g. fats/special paints, screening tests must be made)	
Upper range value	3 000 ml/min	
Accuracy for water (at 23° C ± 2 K and 1 bar)	0 ... 30 ml/min: ± 0.3 ml/min	
	30 ... 3 000 ml/min: ± 1.0 %	
Calibration	Factory calibrated for water at 23 °C ±2 K, outlet of the tubes depressurized (0 bar), other calibration on request	
Zero stability	0.375 ml/min	
Pressure drop at nominal flow rate	0.95 bar	

Measuring method	Ultrasound
Measuring cycle	Typical 20 ms (4 ms min)
Indirect temperature measurement	Integrated sensor at the inlet (accuracy of temperature sensor ± 1 °C)
Mounting	Fixed installation: 4 x recessed threaded holes M5, depth: 10 mm
Measuring channel	\varnothing 3.0 mm
Adaptor for tube connection	Outer diameter 8 mm, inner diameter 4 mm
Pressure rating	PN10
Material (In contact with fluid)	Measuring channel and measuring cell: PEEK, Seals: Viton / FFKM
Operating voltage	12 ... 30 VDC, ripple max. 10 %, protection against reverse polarity
Current consumption	Maximum 30 mA (with open current, frequency and switching output)
Electrical connection	8-pin M12 Connector, DIN EN 61076-2-101:2012
Shielding	Required: via cable / housing (mounting screws)
Interfaces	<ul style="list-style-type: none"> • Current output for flow rate: 0/4 ... 20 mA • Frequency output for flow rate: 0 ... 20 kHz, 5 V digital • RS485 interface: bus-capable • Switching output: configurable as PNP / NPN / Push-Pull, 0 ... 30 V • Digital input (MODBus on request)
Current output for flow rate	<p>⚠ NOTE: Load to GND. The max. load depends on the operating voltage: 12 V \rightarrow 250 Ω, 15 V \rightarrow 500 Ω, 24 V \rightarrow 1 kΩ, 30 V \rightarrow 1.2 kΩ</p>

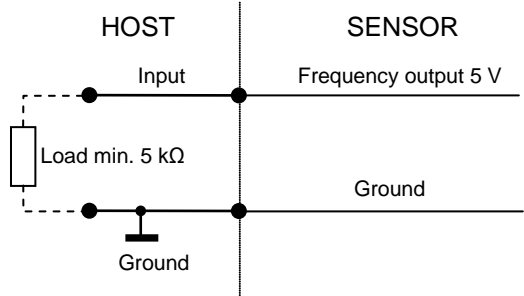
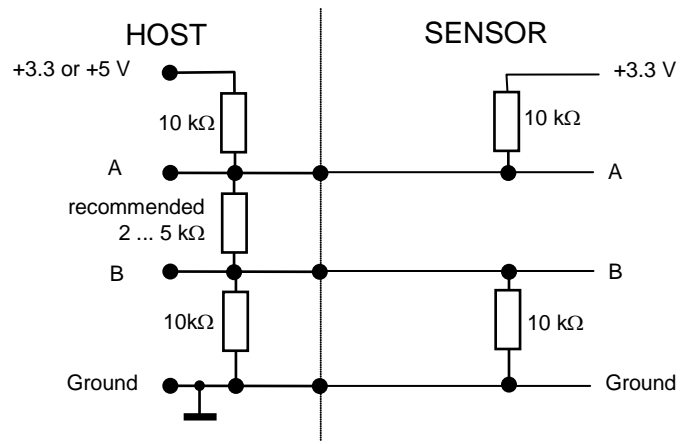
<p>Frequency output for flow rate</p>	
<p>RS485 interface</p>	<p>Half-duplex operation / 115.200 baud / no parity / 1 stop bit / no handshaking</p> <p>⚠ NOTE: Please find the description of the serial protocol for details (upon request).</p>  <p>Recommended electrical connection of the RS 485 interface</p> <p>⚠ CAUTION! If the interface is not used, it does not necessarily has to be connected; the two pins A and B can remain open.</p>
<p>RS485 Bus operation</p>	<p>The sensor supports bus operation with max. 12 subscribers. The default address is #1.</p> <p>⚠ NOTE: The address can be changed with the help of the ABD Monitor. Permitted are addresses from #1 ... #12. → Menu: Identification RS485 address</p>
<p>Switching output</p>	<p>Freely configurable: e.g. adapting batch process or threshold switch of flow, Maximum 100 mA</p>

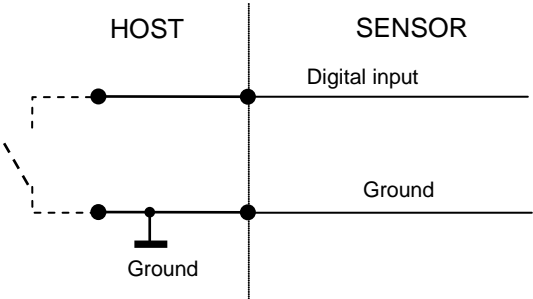
Digital input	<p>Freely configurable: for example for zero point calibration of flow or start dosing processes Voltage resistant up to 30 V</p>
	
Protection class	IP65
Cleaning and sterilization	<p>Maximum liquid temperature: temporarily +145 °C; Resistant to cleaning agents (e.g. caustic soda or 3 percent nitric acid)</p> <p>⚠ NOTE: Verify that the sensor materials (PEEK, Viton/FFKM) are resistant against the cleaning agent.</p>
Media temperature	0 ... +100 °C (temporarily +145 °C)
Ambient temperature	0 ... 70 °C
Storage temperature	-20 ... +70 °C
Directives and standards	<ul style="list-style-type: none"> • EMC directive 2004/108/EG • RoHS: 011/65/EU, exception: III 7cI/ IV 15 • Acoustic emission: IEC 61157
Maintenance	Maintenance-free
Scope of delivery	<ul style="list-style-type: none"> • SONOFLOW IL.52 V2.0 according to specification • User documentation
Optional accessories	<ul style="list-style-type: none"> • 8-pin M12 sensor cable, length 2 m / 5 m • Calibration protocol <p>SONOFLOW Monitor for setting parameters and recording measurements consisting of</p> <ul style="list-style-type: none"> • USB Data Converter, type 013 for the connection to a computer • Power supply unit (24 VDC) • 8-pin M12 connecting cable, length 2 m • USB cable, type A-B, length 2 m • CD with Software SONOFLOW Monitor and driver for Windows

Electrical Connection

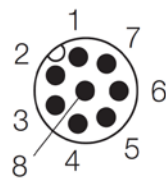

Male connector
(at the sensor)

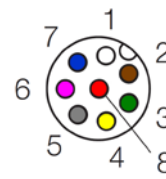

Female connector
(at the cable)

M12 connecting cable	Pin	Colour	Connection
Assignment	1	White	Ground
	2	Brown	Operating voltage +12 ... 30 VDC
	3	Green	Current output (0/4 ... 20 mA)
	4	Yellow	RS485 B
	5	Grey	RS485 A
	6	Pink	Frequency output 0 ... 20 kHz
	7	Blue	Switching output: PNP / NPN / Push-Pull
	8	Red	Digital input

Technical drawings

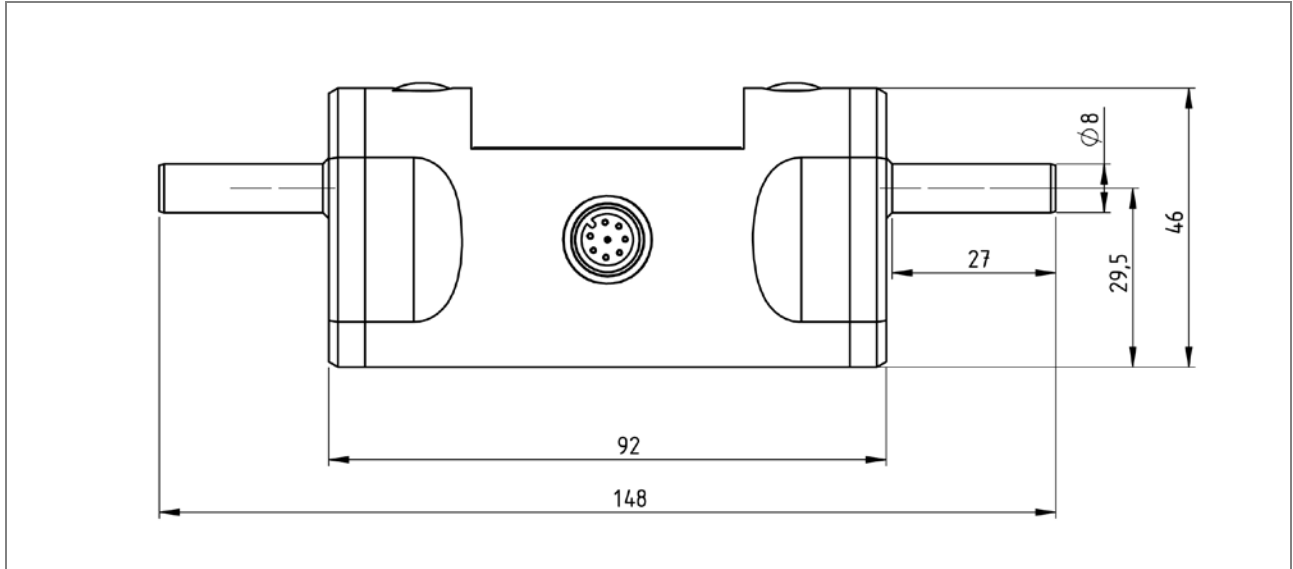

Figure 1: Dimensions SONOFLOW IL.52 V2.0 – Side view

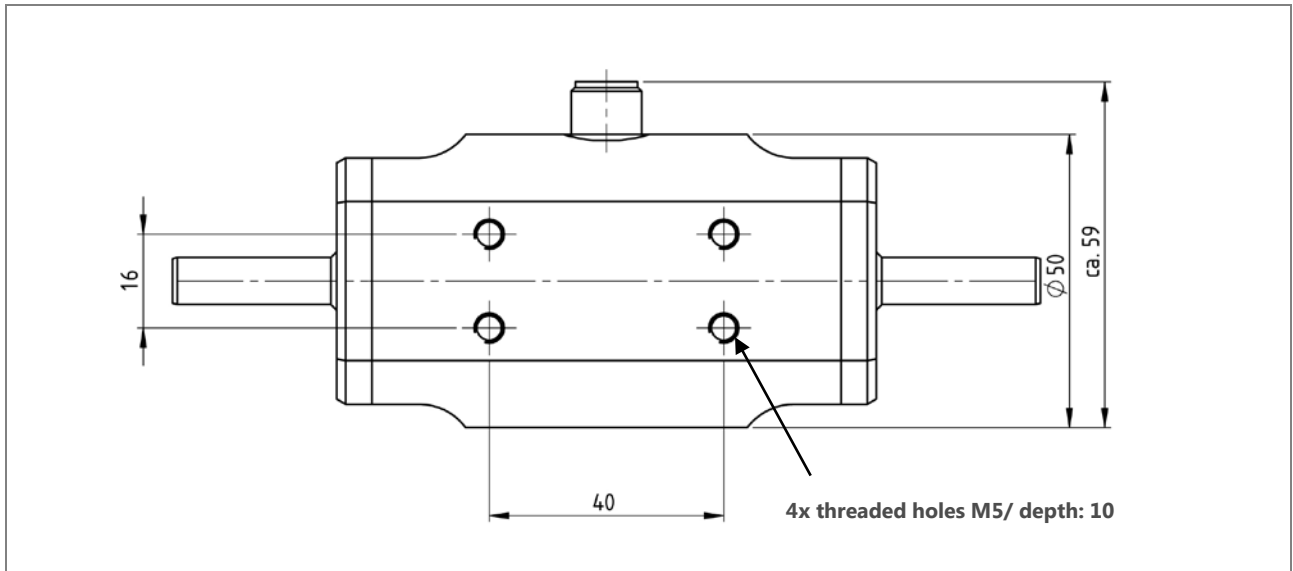

Figure 2: Rear side with drill holes for mounting



3265 Sunset Lane, Hatboro, PA 19040
www.sentinelprocess.com
 P: 800.345.FLOW F: 888.329.9669

Information is subject to change without notice!

HEADQUARTERS GERMANY

SONOTEC
 Ultraschallsensorik Halle GmbH
 Nauendorfer Str. 2
 06112 Halle (Saale), Germany

Tel.: +49 (0)345 / 133 17- 0
sales_eu@sonotec.de
www.sonotec.eu

AMERICAS

SONOTEC US Inc.
 190 Blydenburgh rd
 Suite 8 2nd floor
 Islandia, New York 11749, USA

Phone: +1 631 / 415 4758
sales@sonotecusa.com
www.sonotecusa.com