

**WHITE PAPER**

## **CLAMP-ON FLOW METERS | PROCESS MONITORING**

TECHNOLOGICAL DETAILS & MATHEMATICAL-PHYSICAL DERIVATIONS

ALISON SEDLER, JULIAN GEISER

---

# CONTENT

Preface	3
Non-contact Clamp-on Liquid Flow Meters for Optimized Process Monitoring	3
Process Monitoring with Non-contact Liquid Flow Meters	4
Process Analytical Technology (PAT) Framework	5
Physical Principles of Ultrasonic Flow Measurement	6
Mathematical-physical Derivation of the Calculation	6
Geometric Tube Properties as Important Measurement Criterion	7
Tube Properties & Accurate Non-contact flow measurement	9
SONOFLOW® CO.55 Flow Meters and Their Various Applications	10
SONOFLOW® IL.52 Inline Sensors for Ultra Low Flow	11

---

# Preface

## Non-contact Clamp-on Liquid Flow Meters for Optimized Process Monitoring

### **Alison Sedler**

Director Business Development  
Bioprocessing

SONOTEC US Inc.

### **Julian Geiser**

Development Engineer

SONOTEC GmbH

Process monitoring of liquids in laboratory and production environments enables the continuous control and optimization of critical process parameters. Hence, the early detection of problems is an effective instrument for making processes more efficient, increasing reproducibility and reducing long term costs.

Highly precise and flexible non-contact clamp-on flow sensors are a useful instrument to operate these tasks. Typical fields of application are volume flow monitoring and control, dosing or mixing processes.

## Chapter 1

# Process Monitoring with Non-contact Liquid Flow Meters

Process monitoring is the systematic recording or measurement of an operation or process by means of technical aids [1]. The repeated, regular execution of this process is a central element of its definition. Statistical process control and management enables processes to be optimized and stabilized, and guarantees threshold values to be monitored [2, 3].

Ultrasound based technologies provide ideal measuring methods for this purpose. In particular, the non-invasive character of the measurement and thus the option of gathering data without having to intervene in the actual process makes contactless flow meters ideally suited for both permanent and occasional measurements.

In addition, non-contact flow sensors excel in high precision and ease of use.

Modern ultrasonic flow sensors enable the non-contact flow measurement of a wide variety of liquids in flexible tubes with an accuracy of up to  $\pm 2$  percent of the measured value over a wide flow range. Even under varying media properties and over a wide temperature range, an accuracy of  $\pm 5$  percent of the measured value can be accomplished. With the help of inline flow meters, absolute accuracies in a single-digit  $\mu\text{l/s}$  range can be easily achieved – even at very low flow rates.

**“Continuous flow monitoring on critical points in upstream and downstream bioprocesses is an essential element to fulfill regulatory goals of the Process Analytical Technology (PAT) framework.”**

— Alison Sedler

## Process Analytical Technology (PAT) Framework

The ongoing trend for supporting closed operations with flexible single-use solutions (SUS) designed for continuous processing reflects a paradigm shift in biopharmaceutical facility design. Utilized in almost all new products in early clinical trials so far, SUS are progressively applied in GMP environments as well. The combination of SUS and continuous bioprocessing is changing the industry's conception of itself, having a significant impact on facility design by offering a smaller equipment footprint and substantially lower cleaning requirements. The implementation of a continuous process monitoring, in turn, guarantees to keep process stability and to raise overall efficiency. Critical points in upstream and downstream processes are therefore equipped with flow sensors to fulfill regulatory goals of the **Process Analytical Technology (PAT)** framework.

PAT has been defined as a mechanism to design, analyze, and control biotechnical and pharmaceutical manufacturing processes through the measurement of Critical Process Parameters (CPP). Constant flow monitoring can fundamentally support its overall targets to

- Reduce production cycling time
- Prevent rejection of batches
- Enable real time release
- Increase automation and control
- Improve energy and material use
- Facilitate continuous processing

## Chapter 2

# Physical Principles of Ultrasonic Flow Measurement

One of the main advantages applying ultrasound for flow measurement is the fact, that constant liquid flows can be measured independently of their charge, density or viscosity [4]. A special method of utilizing ultrasonic liquid flow measurement is its non-invasive application. Non-contact flow meters are able to directly measure through the walls of flexible, but also rigid plastic tubes or pipes without interfering with the circuit or coming into contact with the flowing medium. This is possible because the ultrasonic wave is a matter wave.

As long as the liquids are acoustically transparent, the ultrasonic wave propagates.

Sound waves react sensitively to changes or certain properties of the matter permeated by the beam. This effect is exploited in the transit time difference method [5, 6, 7]. The ultrasonic wave can be carried along or slowed down by the flowing medium. This so-called entrainment effect ensures that the flow velocity of the medium – and indirectly the volume flow – can be measured.

## Mathematical-physical Derivation of the Calculation

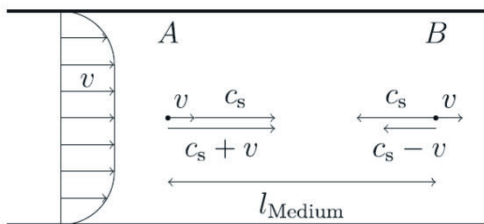

**Figure 1a:** Schematic representation of the transit time principle used for invasive flow measurement along the flow direction (inline flow sensor)

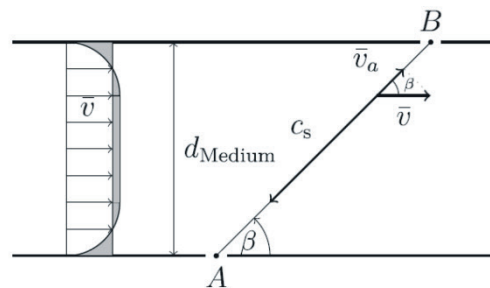

**Figure 1b:** Schematic representation of the transit time principle used for non-invasive flow measurement at an angle  $\beta$  (clamp-on flow sensor)

$$(1) \Delta t = t_{AB} - t_{BA} \text{ with } \Delta t = \frac{2 \cdot L \cdot \cos(\beta)}{c^2} \quad [AB=BA=L]$$

$$(2) v = \frac{c^2 \cdot \Delta t}{2 \cdot L \cdot \cos(\beta)}$$

$$(3) Q = A \cdot v$$

transit time difference of the ultrasound signal with the flow ( $t_{AB}$ ) and against ( $t_{BA}$ ) flow direction as a measure for the flow velocity

$c$ : speed of sound in the medium

$v$ : flow velocity

$A$ : cross-sectional area of the tube

$Q$ : volume flow

## Chapter 3

# Geometric Tube Properties as Important Measurement Criterion

Ultrasonic flow measurement is a time measurement enabling calculation of the velocity of the flowing liquid. A main challenge to get an exact volume flow – especially when measuring non-invasively on the tube – lies in determining the cross-sectional area of the tubing (see separate info box on page 9).

While the cross-sectional area is stable and can be determined unambiguously in the case of rigid plastic pipes or by using inline sensors, there is a significantly higher degree of variability in the case of applying flexible plastic tubes. To ensure an accurate measurement, a sensor adjustment to the customer-specific tube is necessary.

 **Tubing properties have a huge impact on the measurement performance of non-contact clamp-on liquid flow meters.**

The following tubing properties can affect the measurement performance:

- Inner Diameter
- Outer Diameter
- Material
- Durometer
- Manufacturer

Detailed information on the effects of tubing changes can be found in the technical note [„Effects of Tubing Changes on Calibration of SONOFLOW® Ultrasonic Flow Sensors.“](#)

This tech note describes the importance of recalibration and proper adjustment for the specific tubing type being used when tubing changes are made.

According to equation 2,  $v = \frac{c^2 \cdot \Delta t}{2 \cdot L \cdot \cos(\beta)}$

figure 2 shows the transit time difference as a function of the flow velocity in the case of water at a medium temperature of  $T = 23^\circ\text{C}$  for an ultrasonic clamp-on flow sensor (red line), applying an ideally circular tube with an inner diameter (ID) of 4.0 mm. In comparison, the blue line represents an inline flow

sensor with an equally circular channel and an ID of 4.0 mm. Absolute time differences – especially when applying non-contact clamp-on flow meters – can be in the range of a few picoseconds. Inline flow sensors, in turn, can process significantly higher time differences at the same flow velocity to calculate for exact flow rates.

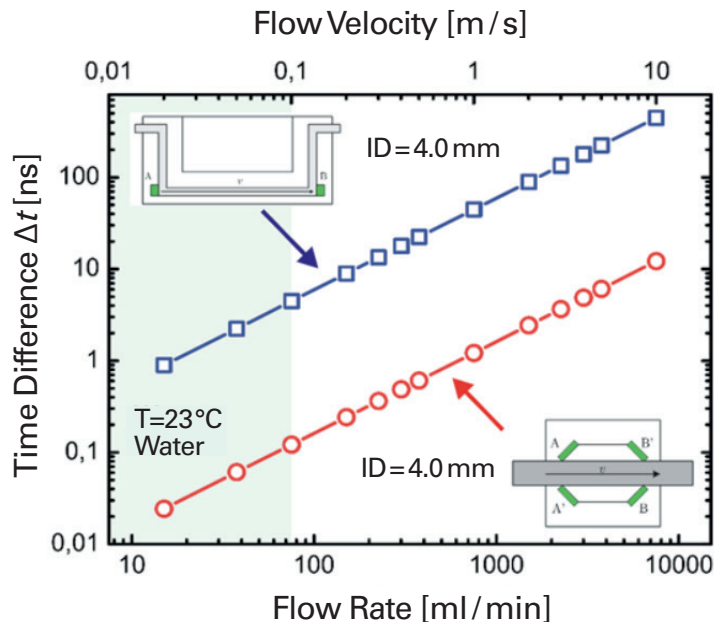

**Figure 2:** Time difference according to equation 2 for water at a medium temperature  $T = 23^\circ\text{C}$  of an inline sensor (blue) and a clamp-on sensor (red), with the measurement along the flowing medium with an inner diameter of  $ID = 4.0\text{ mm}$ . The measuring range with a flow velocity of  $v \leq 0.1\text{ m/s}$  is highlighted in green.

The exact flow measurement requires a highly precise time measurement. Especially for non-invasive clamp-on flow measurement, a high time resolution and low-noise measurement is indispensable. Modern electronic circuits with high-precision timing components enable a time measurement with a resolution in the single-digit

picosecond range. This allows clamp-on flow sensors to stably detect even low flow velocities while maintaining high measuring speed. The fast measuring speed qualifies flow meters to precisely manage even very fast pumping and dosing processes. A major challenge for signal evaluation is to ensure a maximum possible signal-to-noise ratio.

## Tube properties are an important criterion for accurate non-contact flow measurement.

Physical tube properties are said to represent one of the main challenges for an exact clamp-on flow measurement. The cross-sectional area inside the flexible tube is not clearly defined and can hardly be predicted precisely in theory. A variation of the cross-sectional area directly affects the flow rate measurement. The resulting error is added one-to-one to the overall error value. Despite having nominally the same measuring section (red arrow), the cross-sectional area and thus the calculated flow rate may vary considerably (Figure 3a). When a flexible tube is inserted into the channel of the sensor, the cross-sectional area is formed depending on the ratio of inner to outer diameter and the shore hardness of the tube. These effects underline the need for a careful, empirical reconciliation of the geometric factors when calculating the volume flow to a specific tube. This finally leads to a considerable increase in the accuracy of the flow measurement.

In addition to applications with flexible tubes, in which the sound coupling is enabled by softly clinging the tube onto the channel wall (Figure 3a, right), there are fields of application where rigid tubes are used. To ensure a sufficiently stable transmission of the sound wave into the tube and hence into the medium, SONOTEC® has developed a sensor with a flexible inlay to be integrated into various sensor designs. This concept (Figure 3b) enables an easy coupling-agent-free measurement on rigid tubes. By using different parameter files, the sensor can be pre-parametered for the use of different tube settings.

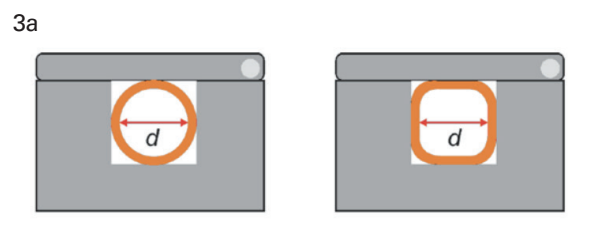

**Figure 3a:** Modification of the cross-sectional area for the same measuring section (red arrow) by clinging to the channel wall.

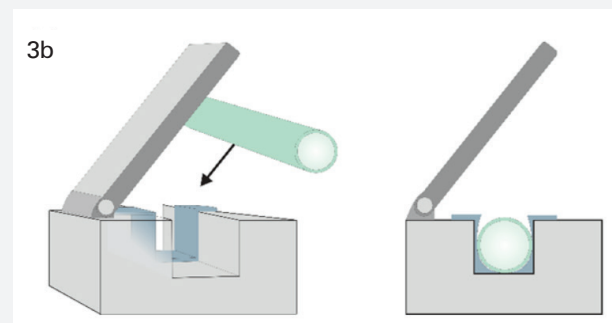

**Figure 3b:** Schematic representation of a clamp-on sensor with flexible inlay (blue). The inlay adapts to the rigid tube (green) and thus allows the sound wave to pass into the medium.

## Chapter 4

# SONOFLOW® CO.55 Flow Meters and Their Various Applications

Non-invasive flow measurement on flexible tubes opens up a wide field of applications. The option of keeping processes running without interruptions and still measuring volume flows in a stable and reliable way is perfectly suited for monitoring and control tasks and their continuous optimization. Figure 4b indicates the relative flow error

of non-contact flow sensors customized to different flow ranges and different tubes in the applications concerned. While reaching an accuracy of  $\pm 5\%$  in the lower flow range of 20 ml/min to 600 ml/min, the sensors can realize accuracies of  $\pm 2\%$  or better for the range of 600 ml/min and beyond that.

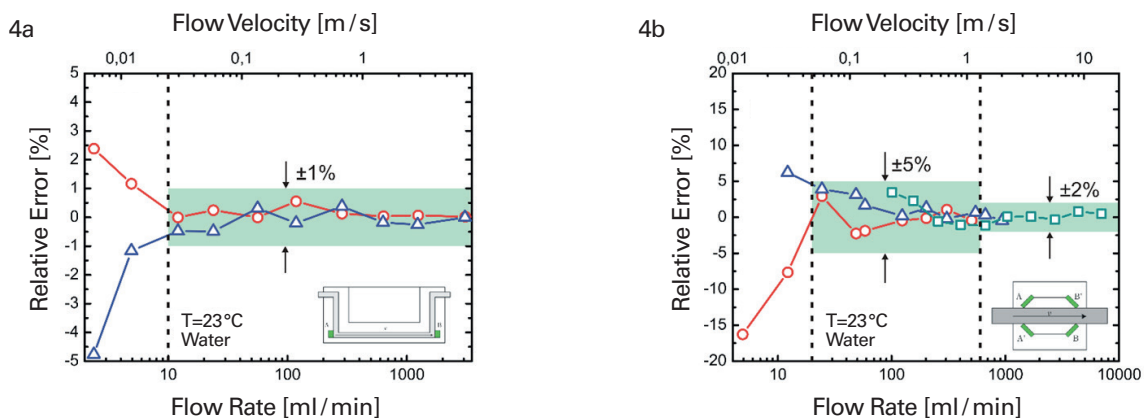

**Figure 4a/4b:** Relative flow error for (a) inline flow sensors as well as for (b) different clamp-on flow sensors adjusted to the respective measuring range with different customer-specific tubes: Green: PVC OD=7.0 mm, ID=5.0 mm; Red: Silicone OD=6.8 mm, ID=4.8 mm; Blue: PVC OD=6.4 mm, ID=4.4 mm. Medium water temperature: T=23°C

## SONOFLOW® Clamp-on Sensor: Non-contact Design

- ① Ultrasonic Transducer | Measurement Principle
- ② M12 Connector | Interfaces
- ③ Measurement Cell | Measurement Accuracy
- ④ Integrated Electronics | Usability

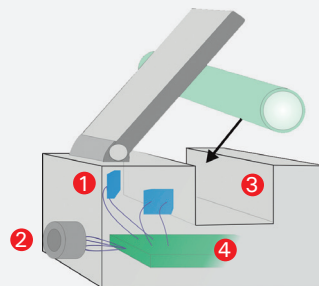

CLAMP-ON FLOW METERS FOR PROCESS MONITORING

## Chapter 5

# SONOFLOW® IL.52 Inline Sensors for Ultra Low Flow

Ultrasonic flow measurement with inline sensors is a well-established and common method. The measurement benefits from a long measuring section parallel to the flowing liquid.

As shown in Figure 2 (page 8), the differences in the measuring effect between clamp-on and inline flow sensors are considerable. Inline sensors can reliably detect down to even the smallest flow rates. Figure 4a (page 10) shows the relative error of the flow measurement of an inline flow meter. With flow rates above 10 ml/min,

an accuracy of  $\pm 1$  percent can be achieved. The resolution of the flow meter is 1  $\mu\text{l/s}$ . The measuring section of the inline sensor is illustrated schematically in Figure 4a (page 10). The ultrasonic transducers – both transmitter and receiver – are indicated as green marking. During flow measurement, the conditions within the measurement path remain stable and can be precisely aligned with the settings. Based on their architecture, inline flow sensors can operate a wide flow range with high measuring accuracy. Hence, a measurement of several  $\mu\text{l/s}$  up to approx. 50 ml/s can be reliably realized.

---

## SOURCES

- [1] Puente León, F., Sommer, K.-D.; Heizmann, M. (Hrsg.); „Verteilte Messsysteme“; KIT Scientific Publishing 2010
- [2] Holst G., Nedß Ch.; „Statistische Versuchsplanung in Zeiten schlanker Produktion“ QZ 39, 1994, Heft 7 S. 756-761
- [3] Linß, Gerhard „Qualitätsmanagement für Ingenieure“ Carl Hanser Verlag 2011
- [4] Püttmer, A.; Linzenkirchner, E.; Hauptmann, P; „Ultraschallsensoren für die Prozesstechnik“ atp – Automatisierungstechnische Praxis 45, 2004, S. 51-59
- [5] Webster, John „The Measurement, Instrumentation and Sensors Handbook“ CRC Press, 1998
- [6] Bonfig, K. W., „Technische Durchflussmessung“, Vulkan Verlag 1987
- [7] Norm ISO 12242 2011. Measurement of fluid flow in closed conduits – Ultrasonic meters for liquid

**SONOTEC GmbH**

Nauendorfer Str. 2  
06112 Halle (Saale)  
Germany

+49 (0)345 / 133 17-0  
+49 (0)345 / 133 17-99  
sonotec@sonotec.de  
www.sonotec.eu



3265 Sunset Lane Hatboro, PA 19040 | 215.675.5700 | sentinelprocess.com

SONOTEC® preserves the right to change technical specifications without further notice.  
(Rev. 1 / 2020-06-16)